



# Peak Smart Rig

By Puffco

\$ 379.99



For Dabs & Wax



Includes Quartz Banger



**PUFFCO**

## SHARE THE VIEW:

Use **#PuffcoPeak** to share your experience.  
We'll share your photos and videos with our  
global audience (seriously we will).











## YOU'RE ALMOST TO THE TOP!

We know it's a drag, but please read through all the instructions. This device is the first of its kind, and we'd like you to learn the easy way by reading this booklet. Also, you'll learn some secret tips and tricks along the way.

 = *Tips to get the most out of your Peak*

---

-  *Whats inside / p 3*
-  *Quick start / p 4 - 8*
-  *Temperature settings / p 9*
-  *Battery / p 9*
-  *Cleaning your device / p 10*
-  *Tips and Tricks / p 11*
-  *Warnings / p 11*
-  *Peak Protection / p 12*
-  *Legal / p 13*

## WHAT'S INSIDE:

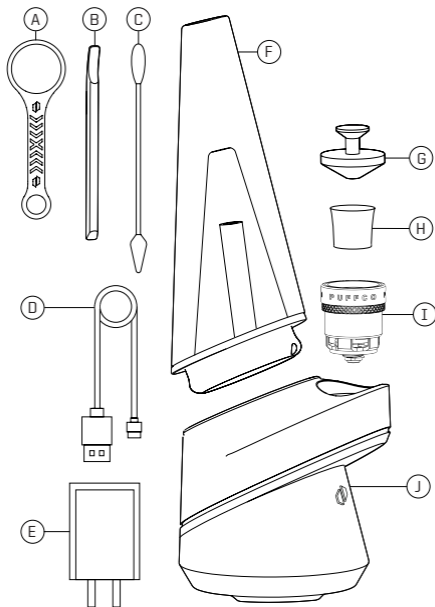

A: Tether

B: The Peak Dab Tool

C: Cotton swabs (4)

D: USB cable

E: AC adapter

F: Glass attachment\*

G: Carb Cap\*

H: Ceramic Bowl

I: Atomizer\*\*

J: Base

\*Each glass piece is hand blown, and may vary slightly in size.

\*\*Part (I) requires periodic replacement.

## QUICK START:

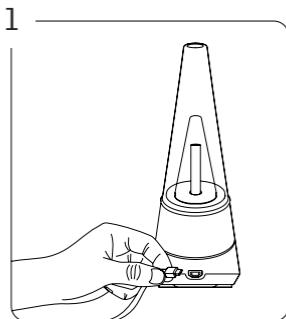

STEP 1: Fully charge device before first use. Device pulses white while charging, and turns off automatically when complete.

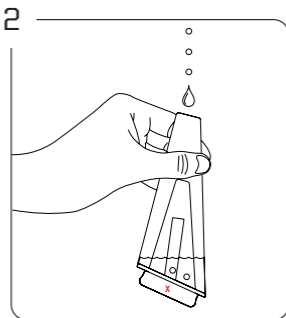

STEP 2: Fill glass with water just above the air-holes. Do not fill glass while attached to base.

**(i)** = Water will damage base and atomizer!

**(i)** = Do not overfill glass.

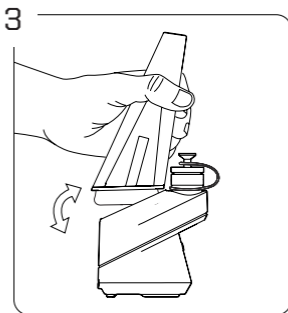

STEP 3: Align inlet hole on the front of the glass with atomizer. Carefully push the front of glass into the base, then the back.

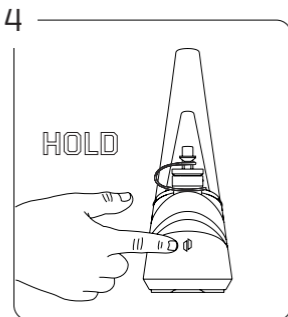

STEP 4: To power the device on/off, hold down the button for 3 seconds. ⓘ = Power down when finished to conserve battery life.

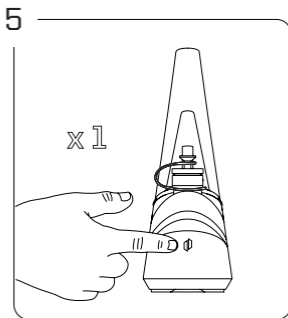

STEP 5: Single click to toggle through heat settings.

BLUE (Low) - GREEN (Medium)

RED (High) - WHITE (Peak)

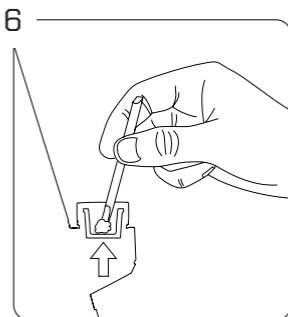

STEP 6: Use The Peak Dab Tool to place contents on the bottom surface of the bowl (not the side). ⓘ = Do not overfill. Overfilling can damage your atomizer.



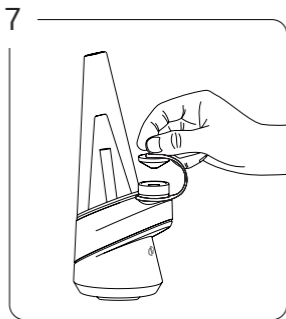

STEP 7: Place carb cap on top of atomizer.

**i** = Protect your carb cap by using the tether provided.

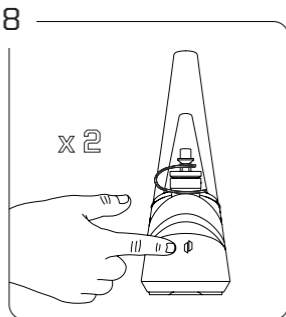

STEP 8: Double click to initiate heat-up. Press and hold button anytime to exit. Pulsing light indicates heat-up mode is active. **i**\* See p. 11 for sesh mode.

9

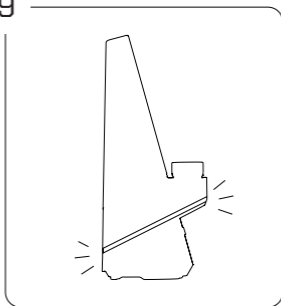

STEP 9: Device will vibrate and lights will flash 3 times when ready. ⓘ = *Inhaling gently will produce the best results.*

10

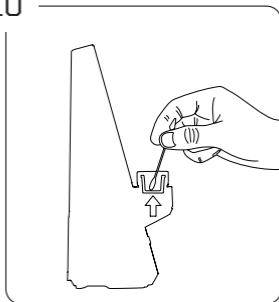

STEP 10: Use a cotton swab to clean the bowl after each use.

## TEMPERATURE SETTINGS:

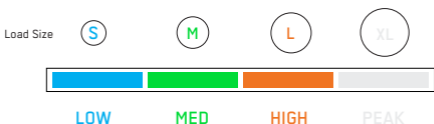

To cycle through the 4 temperature settings, click the button once, and repeat to cycle through the settings.

Average heat-up time is around 20 seconds.

The Peak device features intelligent temperature calibration, which provides a more consistent experience during repeated use. This means that all heat up times may vary.

 = Do not overfill bowl

## BATTERY:



100% - 60%



60% - 20%



20% - 0%

Click the button 3 times to check battery life. Color will indicate remaining battery life. Battery fully charges in approximately 2.5 hours.

 = Power down your device after you're finished to preserve battery life.

## CLEANING:



**Preparation:** Remove glass before unscrewing and re-inserting atomizer (do not overtighten, don't force it).

1. Clean carb cap and glass by soaking in isopropyl alcohol. Rinse clean with water after.
2. Clean gold threads and connector in the base with a cotton swab.
3. To clean the atomizer, unscrew from base, and drop the fully assembled atomizer into iso for 30 minutes.  
\*Be careful removing the atomizer after it was just used, it will be hot to the touch. Allow time to cool.

**WARNING:** After cleaning, allow all parts to thoroughly dry before use. (iso is flammable)

- \*Do not get the base wet - it's electric - it will break.
- \*Do NOT attempt to disassemble the atomizer before submerging fully assembled into iso.

## TIPS AND TRICKS:

### Sesh Mode:

Haven't reached your peak? We've got you covered. We created a sesh mode that increases heat and extends your session by 15 seconds. Use it to boost heat, or to share with your friends.

If vapor production is low, double click to initiate sesh mode. Still not enough? Damn you're hardcore, so sesh again! You can double click as many times as you want to keep the session going.

## WARNINGS:

**Multicolored light flash:** Indicates poor or no connection between the base and atomizer.

**3 red flashes:** Indicates low battery.

**5 light flashes:** Indicates short circuit.

**Red light holds:** Device overheated.

- Do not forcefully remove the bowl, submerge whole atomizer in iso while fully assembled.
- Do not handle atomizer and bowl after use. Allow time to cool.
- Atomizer buzzing is normal, don't worry.
- Do not allow water in the bottom chamber of glass.
- Do not let water seep into the atomizer.
- Do not store device with water in the glass.
- Attach / detach glass carefully, do not force.
- Several short inhales produce more vapor.
- Do not overfill the bowl.
- Do not charge or operate below 32° F or above 100° F.
- Keep away from moisture and high humidity.
- Store in a cool dark place when not in use.



- PUFFCO QUALITY GUARANTEE -

## PEAK PROTECTION:

Peak Protection keeps your device performing at its best, ensuring an optimal experience each time. Should you encounter an issue, first, visit [Puffco.com](https://Puffco.com) to view FAQ's (most answers can be found there). If not, you can livechat with a specialist at [Puffco.com](https://Puffco.com) or contact our customer care team by emailing [Support@Puffco.com](mailto:Support@Puffco.com)

### **Puffco One-Year Limited Warranty Summary:**

Puffco provides one year of coverage for only the electronic base. This covers defects in materials and workmanship for one year from the date of original retail purchase. Puffco does not warrant glass, atomizers, normal wear and tear, or damage caused by accident or abuse. To obtain service, email Puffco customer care at [Support@Puffco.com](mailto:Support@Puffco.com) or visit <https://Support.Puffco.com/hc/en-us>. Call charges and international shipping charges may apply, depending on the location. Subject to the full terms and detailed information listed on Puffco's website under local consumer laws. You may be required to furnish proof of purchase details, and/or the device itself when making a claim under this warranty. Do not attempt to open the Puffco Peak base, this will immediately void the warranty for your product.

✉ [Support@Puffco.com](mailto:Support@Puffco.com)

## LEGAL:

For all Puffco products, strictly use as intended. Puffco units should be used only by persons of legal age in congruence with state and or federal law.

Know that Puffco reserves the right to verify the age of the consumer prior to every purchase.

Registered Puffco products are not intended for any use which is illegal under any state or federal law.

Moreover, Puffco products aren't intended to diagnose, prevent, treat, or cure any disease or medical condition. If you are pregnant, nursing, taking medication for a medical condition, or suspect you have a medical condition, please consult your physician before using any Puffco product.

This device complies with Part 15 of the FCC Rules. Operation is subject to the following two conditions: (1) this device may not cause harmful interference, and (2) this device must accept any interference received, including interference that may cause undesired operation.

Thank you for choosing Puffco. Welcome to the family! Puffco products are designed and engineered in Brooklyn, NY and assembled in China.





## SHARE THE VIEW:

Use **#PuffcoPeak** to share your experience.

Kindly follow us on instagram!

 **Puffco**





770-00003

by Puffco Creation Labs - Subject to alterations · All rights reserved

Smoke  
Cartel

Online Headshop

[www.smokecartel.com](http://www.smokecartel.com)